

/ Perfect Welding / Solar Energy / Perfect Charging

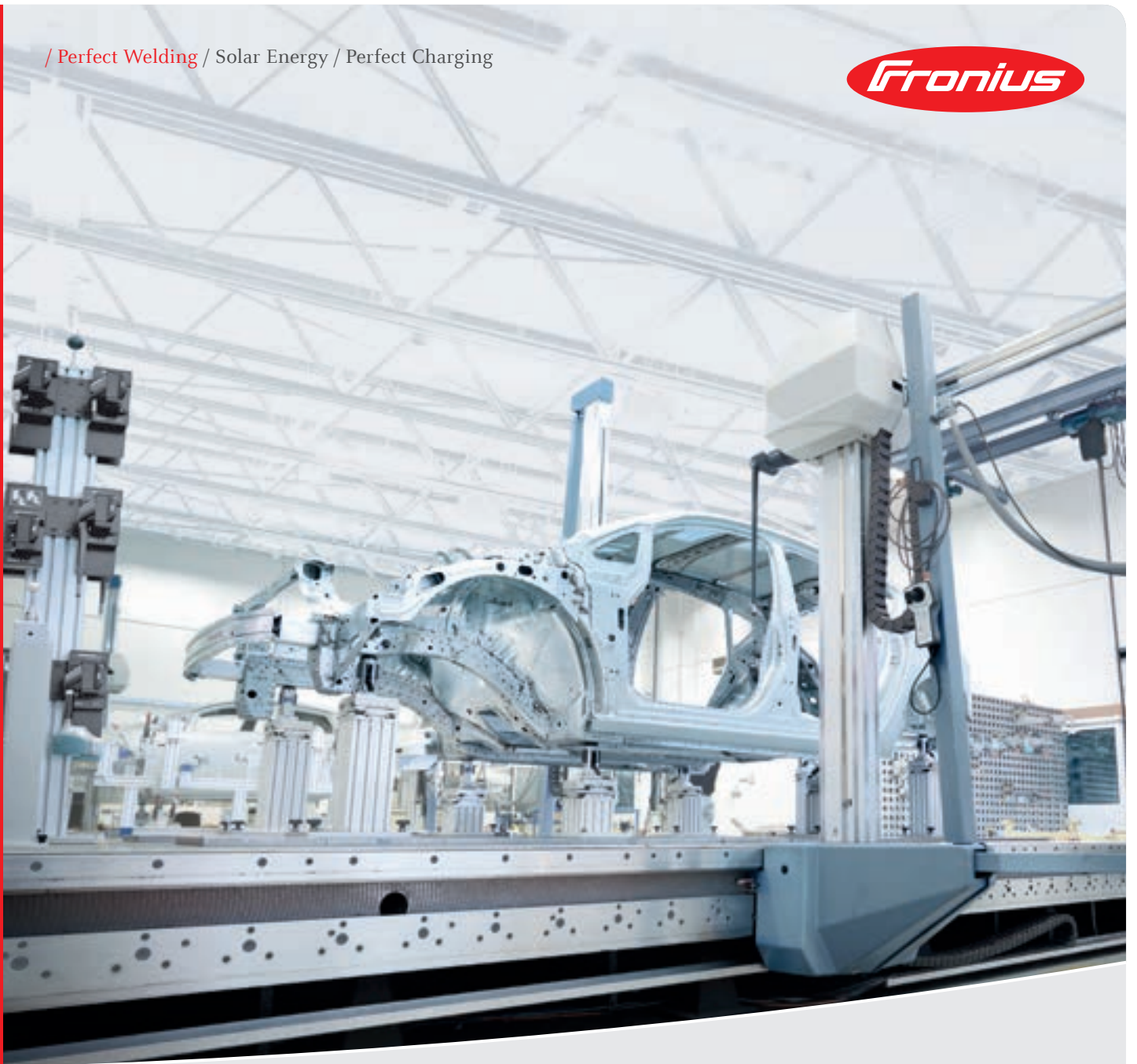

COLD METAL TRANSFER

/ The technology



CMT: THREE LETTERS THAT STAND FOR THE MOST STABLE WELDING PROCESS FROM FRONIUS.

/ The “cold” welding process CMT means outstanding results with all materials, an extremely stable arc, and precision process-control. What makes this possible is that compared to conventional MIG/MAG welding, this process really is “cold”. Or to put it more accurately, one that constantly alternates between hot and cold. This leads to immaculate results and boundless possibilities – such as spatter-free welding- and brazing seams, welded joints between steel and aluminium, welding ultra-light gauge sheets from only 0.3 mm thick, and much else besides.

INTEGRATED WIRE MOTIONS

/ The digital process-control detects a short circuit, then helps to detach the droplet by retracting the wire – up to 130 times a second!

EXCEPTIONALLY LOW THERMAL INPUT

/ During welding, the wire moves forward – and is pulled back again as soon as the short circuit happens. This means that in the arcing phase, the arc itself only inputs heat very briefly.

NO SPATTERING

/ The rearward movement of the wire assists droplet detachment during the short circuit. The short circuit is controlled, and the current is kept small. The result: spatter-free metal transfer.

EXTREMELY STABLE ARC

/ The arc length is detected and adjusted mechanically. The arc remains stable, no matter what the surface of your work-piece is like or how fast you want to weld. This means that you can use CMT everywhere and in every position.

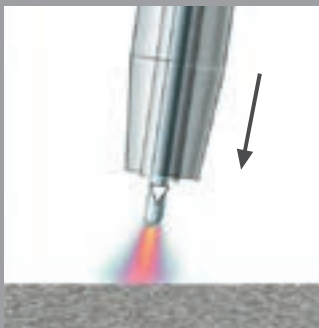

/ During the arcing period, the filler metal is moved towards the weld-pool.

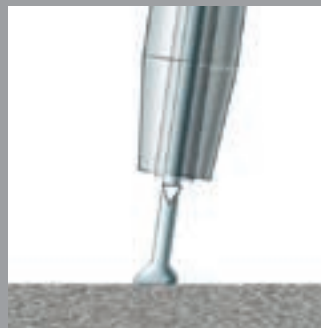

/ When the filler metal dips into the weld-pool, the arc is extinguished. The welding current is lowered.

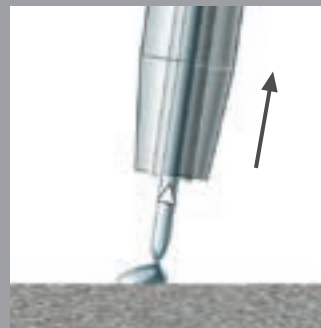

/ The rearward movement of the wire assists droplet detachment during the short circuit. The short-circuit current is kept small.

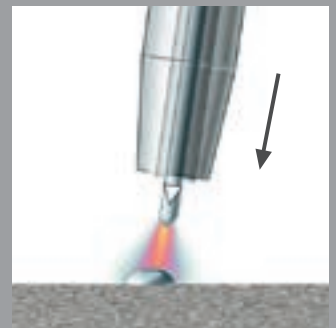

/ The wire motion is reversed and the process begins all over again.



YOU CAN ALWAYS MAKE A BETTER THING EVEN BETTER: CMT PULSE, CMT ADVANCED AND CMT ADVANCED PULSE.

/ For extremely difficult seams and very special requirements, we have refined and combined CMT still further. The result is three additional processes that let you find the perfect solution for virtually any application. And that ensure outstanding results.

CMT PULSE

/ This process combines a pulsed cycle with a CMT cycle and so inputs more heat. Introducing pulses in this carefully controlled, adjustable way results in a huge breadth of performance and flexibility.

/ Combination of CMT cycles and pulsing cycles



/ CMT



/ Pulsed-arc positive



/ Pulsed-arc positive



/ CMT

COMPARISON OF ARC TECHNOLOGIES

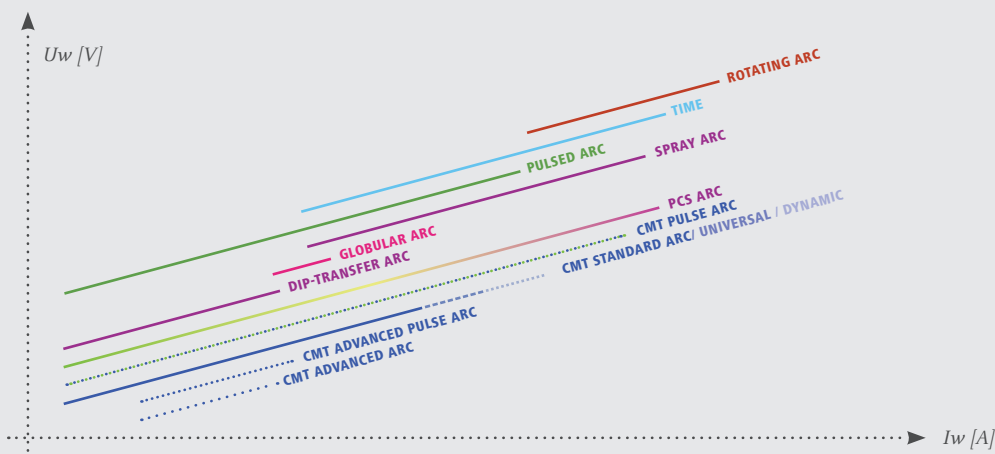

CMT ADVANCED

/ Even “cooler” than CMT. Here, the polarity of the welding current is made an integral part of the process-control. The polarity reversal takes place in the short-circuit phase, thereby ensuring the proven stability of the CMT process. The results: tightly controlled thermal input, extremely high gap bridgeability and an up to 60 % bigger deposition rate.

/ Combination of CMT negative and CMT positive



/ CMT negative



/ CMT negative



/ Initialisation

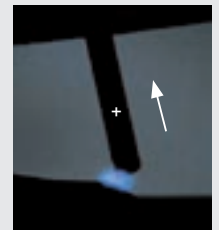

/ CMT positive

CMT ADVANCED PULSE

/ By combining negatively poled CMT cycles and positively poled pulsing cycles, this process achieves absolute precision and the very greatest mastery of the arc.

/ Combination of CMT negative and pulsing cycles



/ CMT negative



/ Initialisation



/ Pulsed-arc positive

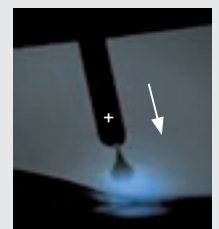

/ Pulsed-arc positive

CMT IN PRACTICE: HIGHLIGHTS AND APPLICATIONS.

/ CMT has some crucial advantages going for it – as our sample applications impressively demonstrate.

EXCELLENT GAP- BRIDGING ABILITY

.....
/ With CMT Advanced, gap bridgeability increases on e.g. 2 mm aluminium from 1 mm to 2.5 mm as compared with pulsed-arc welding.

50 % LESS DILUTION OF BASE AND FILLER METAL

.....
/ Dilution of base and filler metal is as much as 50 % lower, cutting costs when cladding.

ULTRA-HIGH-PRECISION WELDING PROCESS

.....
/ Boasting 100 % reproducibility and the best process-control you'll find, CMT opens up radically new fields of application like CMT Pin and CMT Print.

EXTREMELY LOW SPATTERING

/ Spattering on e.g. steel is cut by as much as 99 % compared to pulsed-arc and dip-transfer welding.

MINIMAL DISTORTION

/ The lower heat input leads to less distortion on e.g. thinner steel. This reduces the need for weld preparation and finishing work.

EXCEPTIONALLY LOW THERMAL INPUT

/ Up to 90 % less thermal input than with TIG cold-wire, e.g. when using CMT on aluminium

HIGHER WELDING SPEEDS

/ Up to 10 times faster for the same seam quality and same sidewall-wetting behaviour, e.g. on chrome-nickel – with excellent seam appearance.

CMT TWIN

/ A simplified system configuration and synchronised start-up of two separately controllable power sources, two wire electrodes and a gas nozzle, combined with the tried-and-tested CMT process. Unbeatable arc stability coupled with deep penetration, optimum wetting to sidewalls, and low-spatter welding.

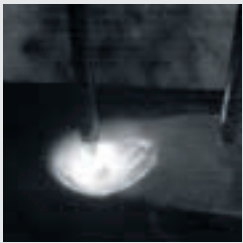

/ CMT Twin weld process

MAX. WELDING SPEED IN PB POSITION

- / No undercutting
- / Reliable penetration
- / Virtually spatter-free

$V_{weld} = 3.0 \text{ m/min}$

$V_{wire_L} = 15.5 \text{ m/min}$ $V_{wire_T} = 6.2 \text{ m/min}$

407 A 196 A

28.5 V 15.0 V



/ Steel, 3 mm

BIGGEST 'A' DIMENSION IN PB POSITION

- / No weldment manipulation needed
- / Ideal weld-seam position (at 45°)
- / Optimised wetting to sidewalls

$V_{weld} = 66 \text{ cm/min}$

$V_{wire_L} = 15.0 \text{ m/min}$ $V_{wire_T} = 8.0 \text{ m/min}$

391 A 214 A

28.3 V 17.0 V



/ Steel, 10 mm, 'a'-dimension = 6

CMT UNIVERSAL / CMT DYNAMIC

The back-and-forward motion of the wire has been increased to 130 Hz. Also, the current profile of the characteristics has been re-engineered to raise the operating limit of CMT even further.

CMT Universal and CMT Dynamic are characterised by a higher-frequency (up to 130 Hz) back-and-forward motion of the wire, deeper penetration and even less spattering.

CMT UNIVERSAL

Enhanced CMT characteristic for all standard applications, which stands out for its good gap-bridging ability.

CMT DYNAMIC

Enhanced CMT characteristic for applications where welding speed and penetration are most important.

DIP-TRANSFER ARC

/ Filler metal = G3Si1 / ER70S-6

/ Shielding gas = M21 / Ar+18%CO₂

$V_{weld} [cm/min] = 33$

$V_{wire} [m/min] = 4.5$

175 A, 18.2 V

'a'-dimension: 3.44 mm

Penetration = 0.33 mm

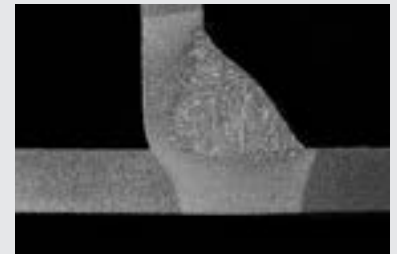

/ Steel, 3 mm

GLOBULAR ARC

/ Filler metal = G3Si1 / ER70S-6

/ Shielding gas = M21 / Ar+18%CO₂

$V_{weld} [cm/min] = 80$

$V_{wire} [m/min] = 8.5$

265 A, 26.3 V

Tendency to spatter

'a'-dimension 3.61 mm

Penetration = 0.54 mm

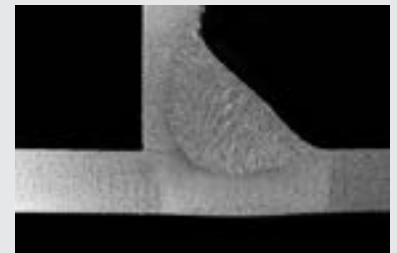

/ Steel, 3 mm

CMT UNIVERSAL

/ Filler metal = G3Si1 / ER70S-6

/ Shielding gas = M21 / Ar+18%CO₂

UP TO 80 % LESS SPATTER

$V_{weld} [cm/min] = 80$

$V_{wire} [m/min] = 9.0 [9.2]$

253 A, 21.4 V

'a'-dimension: 3.5 mm

Penetration = 0.44 mm

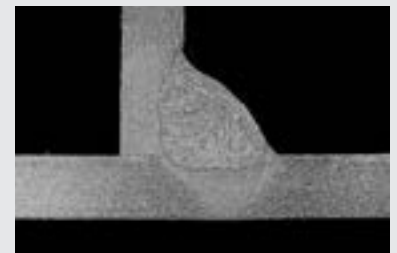

/ Steel, 3 mm

CMT DYNAMIC

/ Filler metal = G3Si1 / ER70S-6

/ Shielding gas = M21 / Ar+18%CO₂

**HIGHER WELDING SPEED,
WITH DEEPER PENETRATION**

$V_{weld} [cm/min] = 100$

$V_{wire} [m/min] = 11 [11.4]$

271 A, 18.8 V

'a'-dimension = 3.55 mm

Penetration = 0.5 mm

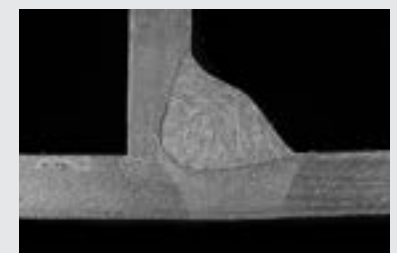

/ Steel, 3 mm

CMT ON STEEL

HIGHER WELDING SPEEDS

+ 50 % VWELD

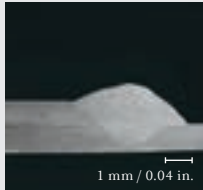

/ Dip-transfer arc
I: 185 A, U: 17.6 V

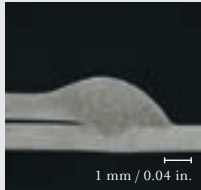

/ CMT
I: 200 A, U: 16.2 V

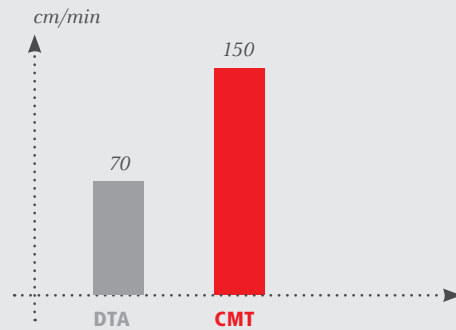

EXTREMELY LOW SPATTERING

/ Steel, measured over 1 m length of weld-seam

-99 % SPATTER



/ Dip-transfer arc



/ Pulsed



/ CMT

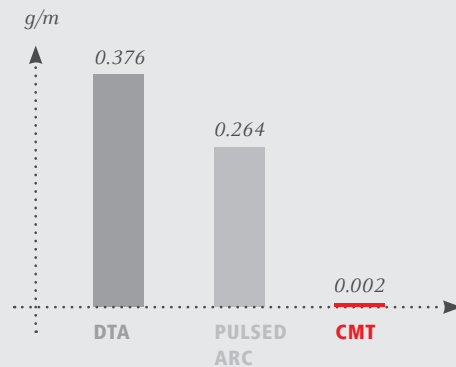

EXCEPTIONALLY LOW THERMAL INPUT (MIXED GAS M 21)

/ Material: Steel 1 mm

-50 % THERMAL INPUT

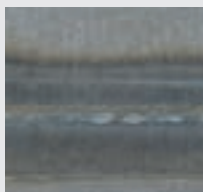

/ Dip-transfer arc
I: 97 A, U: 18.1 V

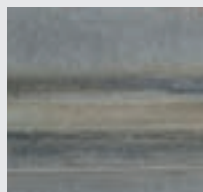

/ CMT
I: 98 A, U: 11.8 V

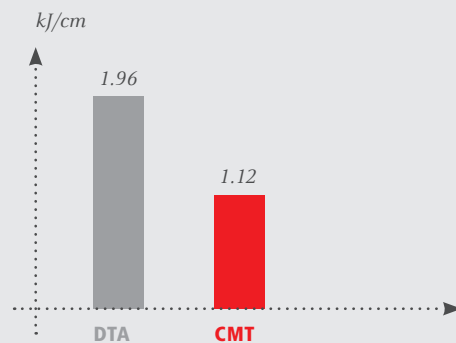

CMT ON ALUMINIUM

ULTRA-LIGHT-GAUGE JOINTS, HIGHER WELDING SPEEDS

LIGHT-GAUGE SHEET 0.3 MM

+ 50 % VWELD

/ Material: Aluminium 0.3 mm

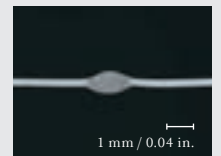
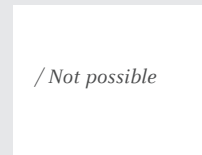

/ Pulsed

/ CMT –
Vweld = 6.4 m/min

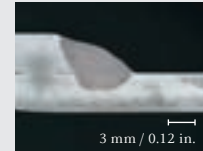

/ Pulsed –
Vweld = 1.1 m/min



/ CMT –
Vweld = 1.7 m/min

/ Material: Aluminium 3 mm

EXCEPTIONALLY LOW THERMAL INPUT, HIGHER WELDING SPEEDS

/ Material: Aluminium 1.6 mm

- 90 % THERMAL INPUT

10 X FASTER

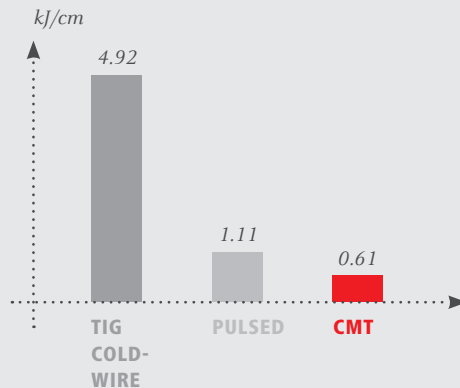

/ TIG cold-wire–
I: 84 A, U: 17.4 V, Vweld: 24 cm/min



/ Pulsed – I: 88 A, U: 18.6 V, Vweld: 100 cm/min

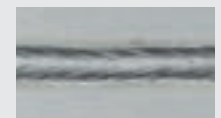

/ CMT– I: 99 A, U: 16.7 V, Vweld: 200 cm/min

EXCELLENT GAP-BRIDGING ABILITY

/ Material: Aluminium 2 mm

2.5 MM GAP

2 mm
1 mm
2 mm

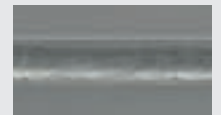

/ Pulsed
I: 100 A, U: 18.9 V, Vwire: 4.5 m, Vweld: 60 cm/min

2 mm
2 mm
2 mm



/ CMT Pulse
I: 97 A, U: 16.9 V, Vwire: 5 m, Vweld: 60 cm/min

2 mm
2.5 mm
2 mm

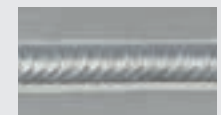

/ CMT Advanced Pulse
I: 97 A, U: 11.9 V, Vwire: 6 m, Vweld: 60 cm/min

CMT STEEL/AL

STEEL/ALUMINIUM HYBRID JOIN

CRASH-TEST PROVEN



CrNi

HIGHER WELDING SPEEDS

/ Material: CrNi 2 mm

5 X FASTER

/ TIG cold-wire

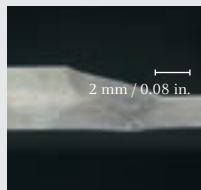

I: 84 A, U: 17.4 V, Vweld: 24 cm/min

/ CMT

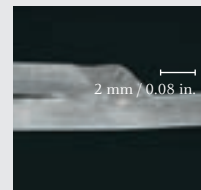

I: 138 A, U: 19 V, Vweld: 130 m/min



CLADDING

EXTREMELY LOW DILUTION DURING CLADDING

-75% DILUTION

+50% VWELD

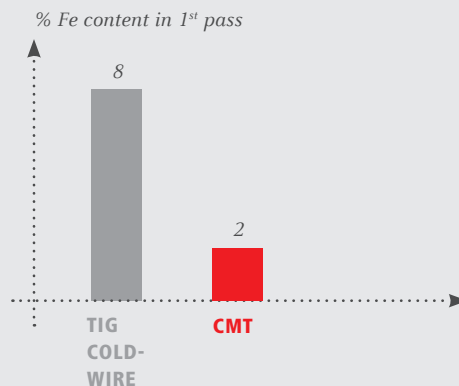

/ TIG cold-wire



Vweld: 40 cm/min

/ CMT



Vweld: 80 cm/min

CO₂ SHIELDING GAS

EXTREMELY LOW SPATTERING WITH CO₂ SHIELDING GAS

/ Steel, measured over 1 m length of weld-seam

-99% SPATTER

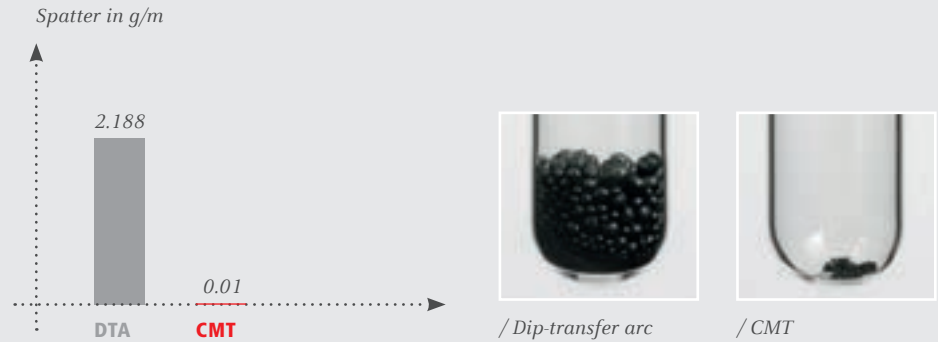

CMT PIN, CMT PRINT

ULTRA-HIGH-PRECISION MIG/MAG WELDING PROCESS

/ The exceedingly high precision of CMT Pin and CMT Print broadens the potential applications of the process

EXTREMELY STABLE MIG/MAG WELDING PROCESS

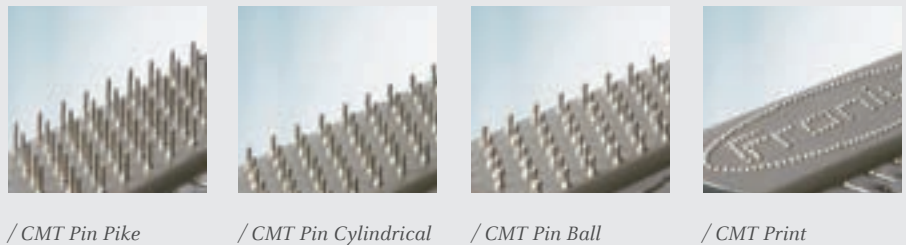

CMT BRAZE+

Existing CMT welding installations can be upgraded to CMT Braze+ with some simple system modifications. A special torch body and an adapted characteristic are all that is needed here.

The extremely narrow conical shape of the gas nozzle makes the shielding gas “constrict” the arc, resulting in unprecedented advantages for CMT brazing:

- / Brazing speed 3 m/min
- / Flat, clean seam with excellent appearance
- / Up to 60 % less shielding gas

STANDARD MIG/MAG TORCH

Normal GMA arc

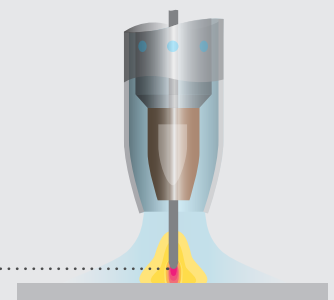

NEW, OPTIMISED MIG/MAG TORCH

Constricted GMA arc

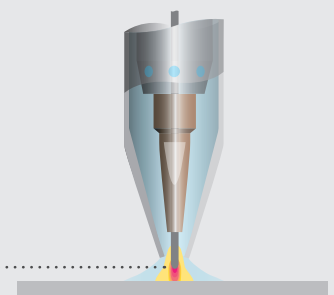

THE IDEAL WELDING SYSTEM, EVERY TIME. FOR EITHER AUTOMATED OR MANUAL PROCESSES.

WIREFEEDER

/ Wirefeed unit with 4-roller drive for feeding the filler metal precisely and smoothly all the way from the wire-spool to the workpiece.

WIRE BUFFER

/ The wire buffer decouples the front and rear wire-drives from one another and ensures smooth wire travel.

DIGITALLY CONTROLLED MIG/MAG WELDING POWER SOURCE

/ The fully digitised microprocessor-controlled inverter power source ensures unrivalled precision in the welding process, with exact reproducibility and superlative welding properties.

COOLING UNIT

/ The rugged and reliable cooling unit is designed to dovetail with the modular concept of the welding system as a whole. It ensures optimum water cooling of the welding torch.



/ If you want to exploit all these capabilities, excellent welding properties and functions to the very full, you need to think in terms of systems. In conjunction with all their peripherals, the digital power sources constitute thoroughly co-ordinated, highly innovative and intelligent welding systems.



ROBACTA DRIVE CMT WELDING TORCH

/ Integrated robot welding torch, equipped with a gearless and highly dynamic AC servo motor that moves the welding wire forward and back up to 130 times a second. It ensures accurate wirefeed and constant contact pressure.

CONTEC CONTACTING SYSTEM

/ Two moveable half-shells keep the contact surfaces and the contact forces between the contacting system and the welding wire exactly in the defined target range. The contact tip abrades uniformly – which minimises the adverse and hard-to-calculate consequences of uneven wear upon the process. Contec is suitable for all diameters and materials of wire.

WE HAVE THREE DIVISIONS AND ONE PASSION: SHIFTING THE LIMITS OF POSSIBILITY.

/ What Günter Fronius started in 1945 in Pettenbach, Austria, has now become a modern day success story. Today, the company has around 3,700 employees worldwide and has been granted more than 800 patents. Our goal has remained constant throughout: to be the innovation leader. We shift the limits of what's possible. While others progress step by step, we innovate in leaps and bounds. The responsible use of our resources forms the basis of our corporate policy.

PERFECT WELDING

/ We develop products and complete systems - both manual and automated - as well as the corresponding services for our customers in the global welding technology market. We have made it our goal to decode the "DNA of the arc".

SOLAR ENERGY

/ The challenge is to make the leap to a regenerative energy supply. Our vision is to use renewable energy to achieve energy independence. With our services, inverters and energy-storage systems for optimising energy yields, we are one of the leading suppliers in the photovoltaics sector.

PERFECT CHARGING

/ As know-how leaders in the world of battery charging, we deliver exceptional solutions to create the maximum benefit for our customers. For the intralogistics sector, we are committed to energy flow optimisation for electric forklift trucks and are constantly striving for the next innovation. Our powerful charging systems for vehicle workshops guarantee safe and reliable processes.

Further information about all Fronius products and our global sales partners and representatives can be found at www.fronius.com

Fronius India Private Limited

GAT no 312, Nanekarwadi
Chakan, Taluka - Khed District
Pune 410501
India
Telephone + 91 98 20 60 52 07
sales.india@fronius.com
www.fronius.in

Fronius (Thailand) Ltd.

Pinthong Industrial Estate I
789/193 Moo 1, Sriracha,
Chonburi 20230
Building: P17/B1
Thailand
sales.Thailand@fronius.com
www.fronius.co.th

Fronius Middle East FZE

P.O. Box: 263241
Jebel Ali / JAFZA ONE BUILDING
Dubai / U.A.E
Telephone +971 (0) 56 499 8224
contact.middleeast@fronius.com
www.fronius.ae/pw

Fronius Canada Ltd.

2875 Argentia Road, Units 4,5 & 6
Mississauga, ON L5N 8G6
Canada
Telephone +1 905 288-2100
Fax +1 905 288-2101
sales.canada@fronius.com
www.fronius.ca

Fronius USA LLC

6797 Fronius Drive
Portage, IN 46368
USA
Telephone +1 877 FRONIUS
sales.usa@fronius.com
www.fronius-usa.com

Fronius UK Limited

Maidstone Road, Kingston
Milton Keynes, MK10 0BD
United Kingdom
Telephone +44 1908 512 300
Fax +44 1908 512 329
info-uk@fronius.com
www.fronius.co.uk

Fronius International GmbH

Froniusplatz 1
4600 Wels
Austria
Telephone +43 7242 241-0
Fax +43 7242 241-953940
sales@fronius.com
www.fronius.com